

Varenummer: 0118019
 Beskrivelse: Seeger låsering H 7

Mål

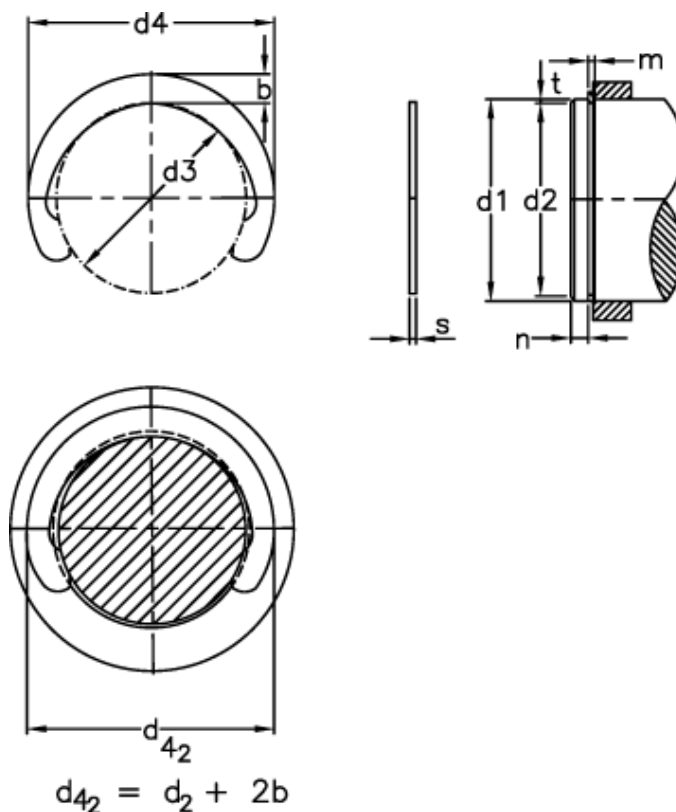

b	= 1.40	FRg kN	= 1.3	t	= 0.50
Betegnelse	= H 7,0	FR kN	= 2.20	tol	= -0.09
d1	= 7	g	= 0.80	tol	= 0.08
d2	= 6.0	Griber	= GRH 7	tol	= -0.05
d3	= 5.80	m min	= 0.85	vægt kg/1000	= 0.13
d4	= 8.60	n abl x 1000	= 69		
d4 2	= 8.8	Nominel træk	= 1.5		
FN kN	= 0.85	s	= 0.80		